

LED SOLUTIONS



LUCOLED

Experience Lighting

LUCOLED

BACK LIGHTING

ECONOMY

EC20	04
EC30	06

PREMIUM

PS20	08
PM30	10
PL30	12
PL35	14

PLUS

BL10	16
BL30	18
BL70	20

EDGE LIGHTING

EL10	22
EL30	24
EL35	26
ELP60	28
ELI30-50-60	30

CONTOUR LIGHTING

LUCOLINE 30	32
LUCOFLEX	34
LUCOFLEX SLIM	36

POWER SUPPLIES / ACCESSOIRES

12V POWER SUPPLIES	40
24V POWER SUPPLIES	40



LUCOLED

Experience Lighting

LUCOLED: NOT JUST ANOTHER LED COMPANY

PAY FOR PERFORMANCE

At LucoLED we operate at the simple principle that the customer should only pay for product performance and not for the overhead and excessive margins most major brands add to their cost.

It is LucoLED's mission to provide fit for purpose, reliable and efficient lighting solutions for visual communication and brand identity.

EXPERIENCE

LucoLED is based on over 20 years of experience in the signage industry and has developed an in depth knowledge of the basic needs of the market. Backed by industry leading design and production facilities LucoLED provides high quality products with exceptional performance and warranties.

LucoLED's ODM production uses state of the art equipment and has extensive R&D facilities. Besides a range of standard products LucoLED can also offer tailor made solutions with minimum lead time.

COMPLETE SOLUTION

LucoLED offers a complete system solution for letters, light boxes, flexible and linear accents. Including their own full range power supplies. LucoLED offers a system warranty of up to 7 years and extended warranties of up to 2 years as we believe in our products.

Although LucoLED is a new name in the market, the management behind the company has a proven track record of quality and reliability.



LUCOLED EC20



- *5 years warranty*
- *Lucolense wide angle technology*
- *High efficacy*
- *Constant Current Technology*
- *Narrow white binning*

Lucoled Eco EC20 modules offer a high quality and efficient backlit solution for lightboxes and channel letters between 60 and 180mm deep.

Using the latest Top-Tier LED technology and high quality optics Lucoled Eco series offers industry leading efficacy and coverage. This not only reduces the amount of modules needed for an application, but also the overall power consumption.

Lucoled Eco series offer a value proposition for everyday projects with a good price-performance ratio.

SPECIFICATIONS

- Dimensions 43x14,5x7,8mm
- Warranty 5 years
- Beam angle: 160°
- Can be cut between every unit
- UL, CE and RoHS compliant
- Narrow white binning
- Constant Current Technology
- Operating temperature -25~+60C



LUMINOUS INTENSITY DISTRIBUTION

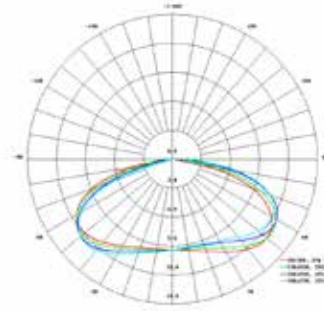

Item no	LED colour	CT (K)	CRI	Power (W/mod)	Flux (lm/mod)	Efficacy (lm/W)	Voltage (DC)	Modules per chain	Modules per carton
EC20-W65	white	6500	>75	0.72	70	97	12	50	2000

DIMENSIONS

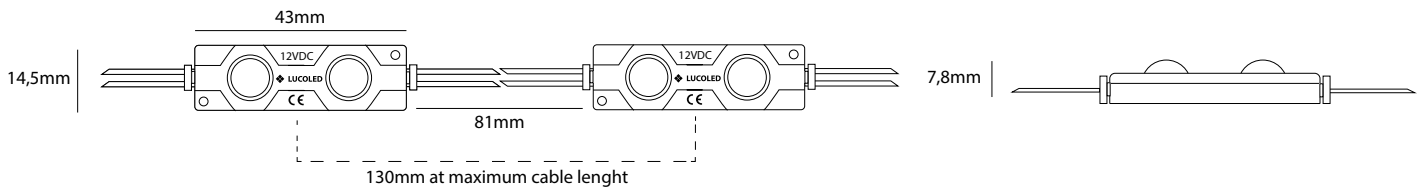

Light box depth (mm)	Space between modules (mm)	Installing density (pcs/m ²)	Surface Illuminance range (cd/m ²)
dz=60	dx=70, dy=60	238	2900-3350
dz=120	dx=130, dy=120	64	850-950
dz=180	dx=130, dy=180	43	450-550

Results may vary depending on face material properties. The data above was obtained using 3mm thick opaque acrylic with a 54% light transmittance. Lucoled advises to paint the inside of the box/ letters in a matt white colour for achieving an optimal result. Always test before production.

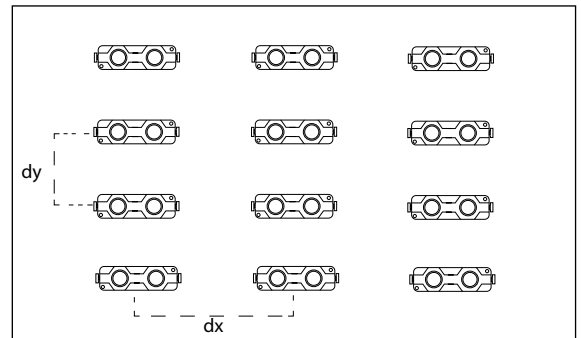

POWER SUPPLY CAPACITY 12V SERIES

Item	PP1230	PP1260	PP12100	PP12150	PP12200
Power Output	30W	60W	100W	150W	200W
EC20 modules / power supply	37	75	125	187	250
Number of chains (maximum 50 modules per chain)	1	2	3	4	5

PACKAGING

Item	Qty (pcs / bag)	Qty (bags / carton)	Total Qty (pcs / carton)	Total weight (kgs)	Carton size (LxWxH) in mm
EC20	100	20	2000	15,5	528 x 376 x 272



adidas

LUCOLED EC30



- *5 years warranty*
- *Lucolense wide angle technology*
- *High efficacy*
- *Constant Current Technology*
- *Narrow white binning*

Lucoled Eco EC30 modules offer a high quality and efficient backlit solution for lightboxes and channel letters between 60 and 180mm deep.

Using the latest Top-Tier LED technology and high quality optics Lucoled Eco series offers industry leading efficacy and coverage. This not only reduces the amount of modules needed for an application, but also the overall power consumption.

Lucoled Eco series offer a value proposition for everyday projects with a good price-performance ratio.

SPECIFICATIONS

- Dimensions 65x14,5x7,8mm
- Warranty 5 years
- Beam angle: 160°
- Can be cut between every unit
- UL, CE and RoHS compliant
- Narrow white binning
- Constant Current Technology
- Operating temperature -25~+60C



LUMINOUS INTENSITY DISTRIBUTION

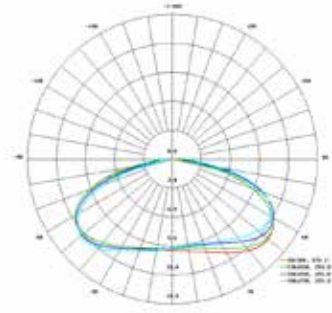

Item no	LED colour	CT (K)	CRI	Power (W/mod)	Flux (lm/mod)	Efficacy (lm/W)	Voltage (DC)	Modules per chain	Modules per carton
EC30-W65	white	6500	>75	1.00	100	100	12	50	1400

DIMENSIONS

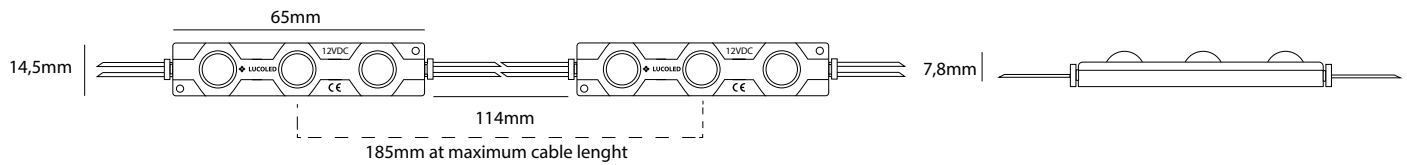

Light box depth (mm)	Space between modules (mm)	Installing density (pcs/m ²)	Surface luminance range (cd/m ²)
dz=60	dx=80, dy=60	208	3850-4400
dz=120	dx=140, dy=120	60	1200-1350
dz=180	dx=180, dy=180	31	600-750

Results may vary depending on face material properties. The data above was obtained using 3mm thick opaque acrylic with a 54% light transmittance. Lucoled advises to paint the inside of the box/ letters in a matt white colour for achieving an optimal result. Always test before production.

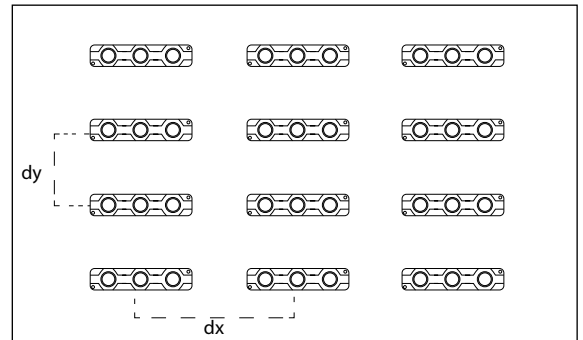

POWER SUPPLY CAPACITY 12V SERIES

Item	PP1230	PP1260	PP12100	PP12150	PP12200
Power Output	30W	60W	100W	150W	200W
EC30 modules / power supply	27	54	90	135	180
Number of chains (maximum 50 modules per chain)	1	2	2	3	4

PACKAGING

Item	Qty (pcs / bag)	Qty (bags / carton)	Total Qty (pcs / carton)	Total weight (kgs)	Carton size (LxWxH) in mm
EC30	100	14	1400	17,5	528 x 376 x 272

next >



LUCOLED PS20



- *7 years warranty*
First 2 years extended warranty
- *Lucolense wide angle technology*
- *High efficacy*
- *Constant Current Technology*
- *Narrow white binning*

Lucoled Premium PS20 modules offer a high quality and efficient backlit solution for lightboxes and channel letters between 40 and 100mm deep.

Using the latest Top-Tier LED technology and high quality optics Lucoled Premium series offers industry leading efficacy and coverage. This not only reduces the amount of modules needed for an application, but also the overall power consumption, reducing the total cost of ownership of a project.

Lucoled Premium series offers a 2 years extended warranty, making it the optimum choice for your high valued projects and critical installations. Your warranty exposure is reduced to a minimum.

SPECIFICATIONS

- Dimensions 33x11x10mm
- Warranty 7 years (first 2 years extended)
- Beam angle: 160°
- Can be cut between every unit
- EL, CE and RoHS compliant
- Narrow white binning
- Constant Current Technology
- Operating temperature -25~+60C

LUMINOUS INTENSITY DISTRIBUTION

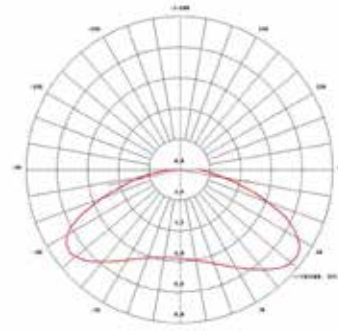

Item no	LED colour	CT (K)	CRI	Power (W/mod)	Flux (lm/mod)	Efficacy (lm/W)	Voltage (DC)	Modules per chain	Modules per carton
PS20-W65	white	6500	>80	0.34	41	120	12	50	1600

DIMENSIONS

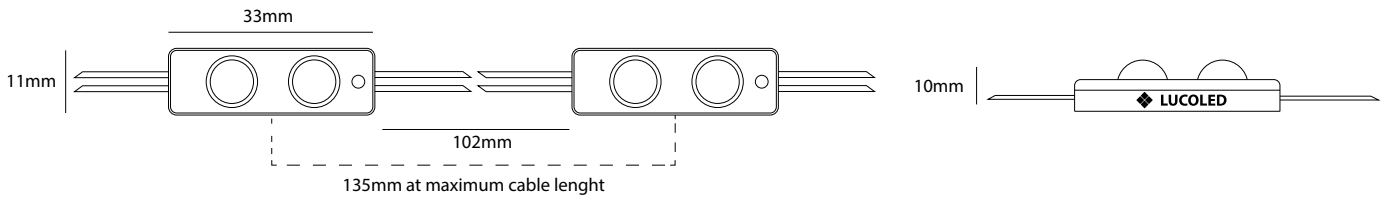

Light box depth (mm)	Space between modules (mm)	Installing density (pcs/m ²)	Surface luminance range (cd/m ²)
dz=40	dx=70, dy=50	286	2890-3155
dz=60	dx=90, dy=70	159	1125-1445
dz=80	dx=110, dy=90	101	660-920
dz=100	dx=130, dy=120	64	410-565

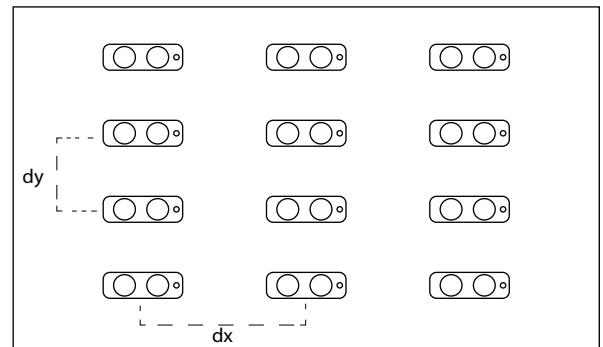

Results may vary depending on face material properties. The data above was obtained using 3mm thick opaque acrylic with a 54% light transmittance. Lucoled advises to paint the inside of the box/ letters in a matt white colour for achieving an optimal result. Always test before production.

POWER SUPPLY CAPACITY 12V SERIES

Item	PP1230	PP1260	PP12100	PP12150	PP12200
Power Output	30W	60W	100W	150W	200W
PS20 modules / power supply	79	158	264	397	529
Number of chains (maximum 50 modules per chain)	2	4	6	8	11

PACKAGING

Item	Qty (pcs/bag)	Qty (bag / carton)	Total Qty (pcs / carton)	Total weight (kgs)	Carton size (LxWxH) in mm
PS20	100	16	1600	11,0	528 x 376 x 272



LUCOLED PM30



- *7 years warranty*
First 2 years extended warranty
- *Lucolense wide angle technology*
- *High efficacy*
- *Constant Current Technology*
- *Narrow white binning*

Lucoled Premium PM30 modules offer a high quality and efficient backlit solution for lightboxes and channel letters between 60 and 120mm deep.

Using the latest Top-Tier LED technology and high quality optics Lucoled Premium series offers industry leading efficacy and coverage. This not only reduces the amount of modules needed for an application, but also the overall power consumption, reducing the total cost of ownership of a project.

Lucoled Premium series offers a 2 years extended warranty, making it the optimum choice for your high valued projects and critical installations. Your warranty exposure is reduced to a minimum.

SPECIFICATIONS

- Dimensions 45x11x10mm
- Warranty 7 years (first 2 years extended)
- Beam angle: 160°
- Can be cut between every unit
- UL, CE and RoHS compliant
- Narrow white binning
- Constant Current Technology
- Operating temperature -25~+60C

LUMINOUS INTENSITY DISTRIBUTION

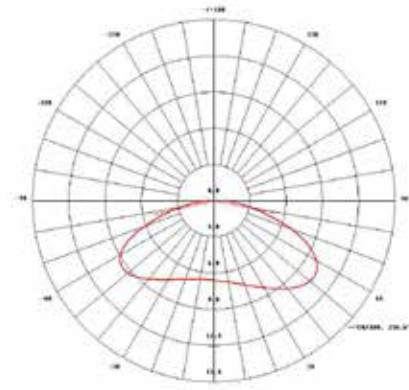

Item no	LED colour	CT (K)	CRI	Power (W/mod)	Flux (lm/mod)	Efficacy (lm/W)	Voltage (DC)	Modules per chain	Modules per carton
PM30-W65	white	6500	>80	0.48	55	114	12	50	1200

DIMENSIONS

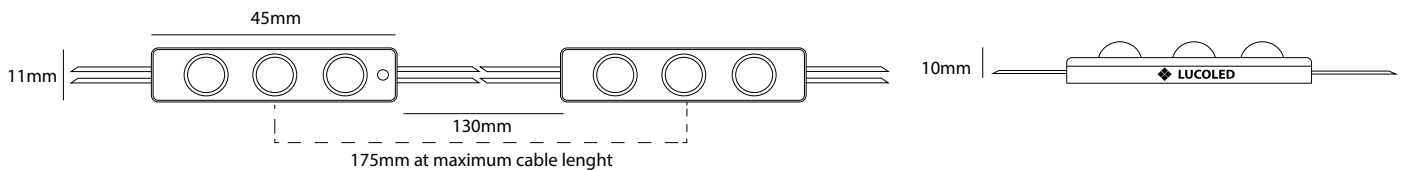

Light box depth (mm)	Space between modules (mm)	Installing density (pcs/m ²)	Surface luminance range (cd/m ²)
dz=60	dx=90, dy=90	123	1370-1525
dz=80	dx=120, dy=120	69	800-945
dz=100	dx=150, dy=150	44	480-620
dz=120	dx=175, dy=175	31	390-480

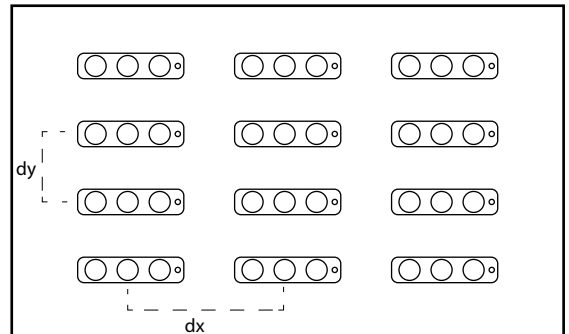

Results may vary depending on face material properties. The data above was obtained using 3mm thick opaque acrylic with a 54% light transmittance. Lucoled advises to paint the inside of the box/letters in a matt white colour for achieving an optimal result. Always test before production.

POWER SUPPLY CAPACITY 12V SERIES

Item	PP1230	PP1260	PP12100	PP12150	PP12200
Power Output	30W	60W	100W	150W	200W
PM30 modules / power supply	56	112	187	281	375
Number of chains (maximum 50 modules per chain)	2	3	4	6	8

PACKAGING

Item	Qty (pcs/bag)	Qty (bag / carton)	Total Qty (pcs / carton)	Total weight (kgs)	Carton size (LxWxH) in mm
PM30	100	12	1200	12,0	528 x 376 x 272

The image shows the Cartier logo in a white, elegant script font mounted on the glass facade of a modern building. The building's architecture features vertical glass panels and a perforated metal screen. The logo is the central focus, with the city skyline visible through the glass behind it.

Cartier

LUCOLED PL30



- *7 years warranty*
First 2 years extended warranty
- *Lucolense wide angle technology*
- *High efficacy*
- *Constant Current Technology*
- *Narrow white binning*

Lucoled Premium PL30 modules offer a high quality and efficient backlit solution for lightboxes and channel letters between 80 and 200mm deep.

Using the latest Top-Tier LED technology and high quality optics Lucoled Premium series offers industry leading efficacy and coverage. This not only reduces the amount of modules needed for an application, but also the overall power consumption, reducing the total cost of ownership of a project.

Lucoled Premium series offers a 2 years extended warranty, making it the optimum choice for your high valued projects and critical installations. Your warranty exposure is reduced to a minimum.

SPECIFICATIONS

- Dimensions 61x11x10mm
- Warranty 7 years (first 2 years extended)
- Beam angle: 160°
- Can be cut between every unit
- EL, CE and RoHS compliant
- Narrow white binning
- Constant Current Technology
- Operating temperature -25~+60C



LUMINOUS INTENSITY DISTRIBUTION

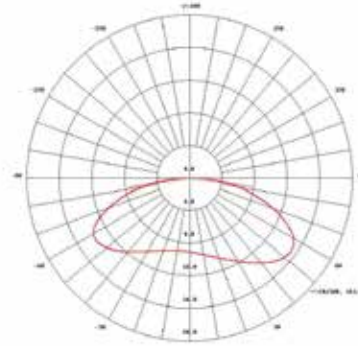

Item no	LED colour	CT (K)	CRI	Power (W/mod)	Flux (lm/mod)	Efficacy (lm/W)	Voltage (DC)	Modules per chain	Modules per carton
PL30-W65	white	6500	>80	0.72	85	118	12	50	1200

DIMENSIONS

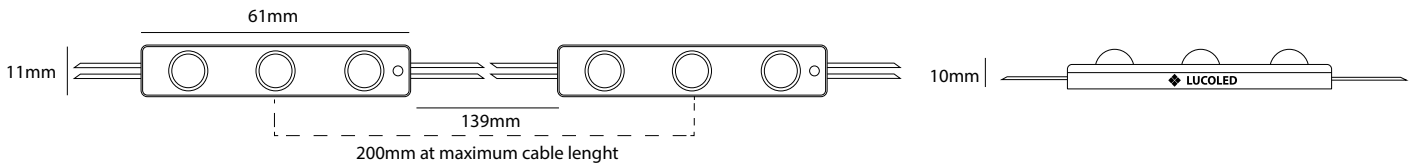

Light box depth (mm)	Space between modules (mm)	Installing density (pcs/m ²)	Surfacelluminance range (cd/m ²)
dz=80	dx=140, dy=120	60	1140-1425
dz=100	dx=180, dy=160	35	745-915
dz=120	dx=200, dy=200	25	510-650
dz=150	dx=200, dy=200	25	465-575
dz=180	dx=200, dy=200	25	450-515

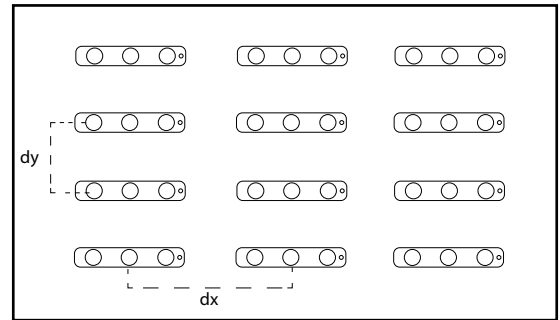

Results may vary depending on face material properties. The data above was obtained using 3mm thick opaque acrylic with a 54% light transmittance. Luceoled advises to paint the inside of the box/letters in a matt white colour for achieving an optimal result. Always test before production.

POWER SUPPLY CAPACITY 12V SERIES

Item	PP1230	PP1260	PP12100	PP12150	PP12200
Power Output	30W	60W	100W	150W	200W
PL30 modules / power supply	37	75	125	187	250
Number of chains (maximum 50 modules per chain)	1	2	3	4	5

PACKAGING

Item	Qty (pcs/bag)	Qty (bag / carton)	Total Qty (pcs / carton)	Total weight (kgs)	Carton size (LxWxH) in mm
PL30	100	12	1200	13,0	528 x 376 x 272

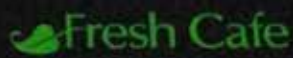

LUCOLED PL35



- *7 years warranty*
- *First 2 years extended warranty*
- *Lucolense wide angle technology*
- *High efficacy*
- *Constant Current Technology*
- *Narrow white binning*

Lucoled Premium PL35 modules offer a high quality and efficient backlit solution for lightboxes and channel letters between 80 and 200mm deep.

Using the latest Top-Tier LED technology and high quality optics Lucoled Premium series offers industry leading efficacy and coverage. This not only reduces the amount of modules needed for an application, but also the overall power consumption, reducing the total cost of ownership of a project.

Lucoled Premium series offers a 2 years extended warranty, making it the optimum choice for your high valued projects and critical installations. Your warranty exposure is reduced to a minimum.

SPECIFICATIONS

- Dimensions 64x13,4x9,2mm
- Warranty 7 years (first 2 years extended)
- Beam angle: 160°
- Can be cut between every unit
- UL, CE and RoHS compliant
- Narrow white binning
- IP68
- Constant Current Technology
- Operating temperature -25~+60C

LUMINOUS INTENSITY DISTRIBUTION

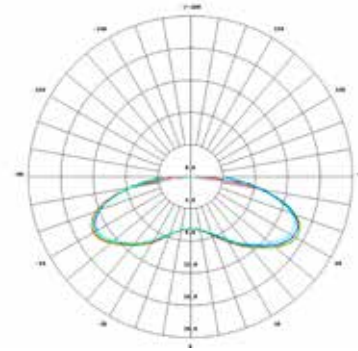

Item no	LED colour	CT (K)	CRI	Power (W/mod)	Flux (lm/mod)	Efficacy (lm/W)	Voltage (DC)	Modules per chain	Modules per carton
PL35-W65	white	6500	>75	1.2	134	113	12	25	1200

DIMENSIONS

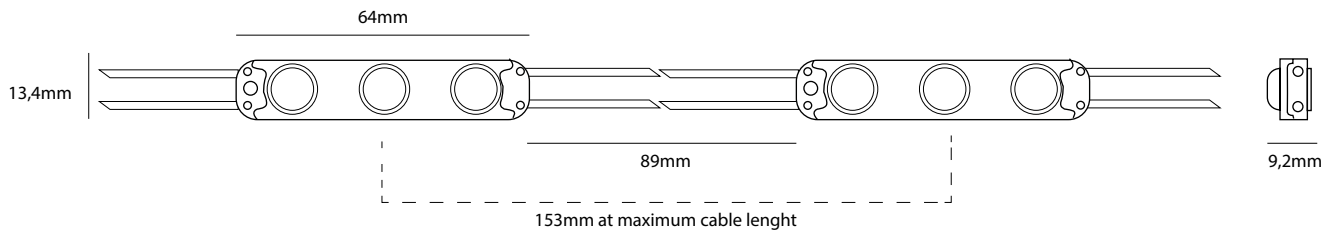

POWER SUPPLY CAPACITY 12V SERIES

Item	PP1230	PP1260	PP12100	PP12150	PP12200
Power Output	30W	60W	100W	150W	200W
PL35 modules / power supply	22	45	75	112	150
Number of chains (maximum 25 modules per chain)	1	2	3	5	6

PACKAGING

Item	Qty (pcs/bag)	Qty (bag / carton)	Total Qty (pcs / carton)	Total weight (kgs)	Carton size (LxWxH) in mm
PL35	100	12	1200	13,28	528x376x272

athlete's co.

LUCOLED BL10



- *5 years warranty*
First 2 years extended warranty
- *Lucolense wide beam technology*
- *High efficacy: 158lm/W*
- *Constant Current Technology*
- *Narrow white binning*

Lucoled Plus BL10 modules offer a high quality and efficient backlit solution for channel letters made from routed full acrylic.

Lucoled Plus BL10 modules are IP65 and can be used without the need for fully potting the acrylic letters. This makes the production process much cleaner and faster. Potting material can also damage LED phosphor and can have a colour shift and reduced life as a result. The BL10 is a fully enclosed module and does not have this disadvantage.

Lucoled Plus BL10 can also be used in very narrow and small traditional channel letters.

SPECIFICATIONS

- Dimensions 13x7x7mm
- Warranty 5 years (first 2 years extended)
- Beam angle: 120°
- Can be cut between every unit
- UL, CE and RoHS compliant
- Narrow white binning
- Constant Current Technology
- Operating temperature -25~+60C



LUMINOUS INTENSITY DISTRIBUTION

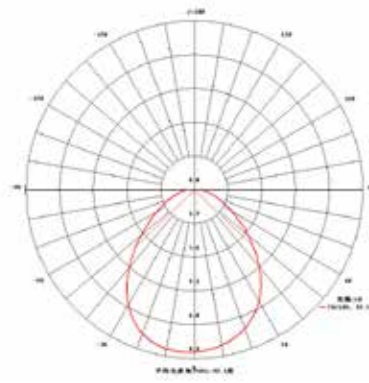

Item no	LED colour	CT (K)	CRI	Power (W/mod)	Flux (lm/mod)	Efficacy (lm/W)	Voltage (DC)	Modules per chain	Modules per carton
BL10-W65	white	6500	>70	0.24	38	158	12	50	6000

DIMENSIONS

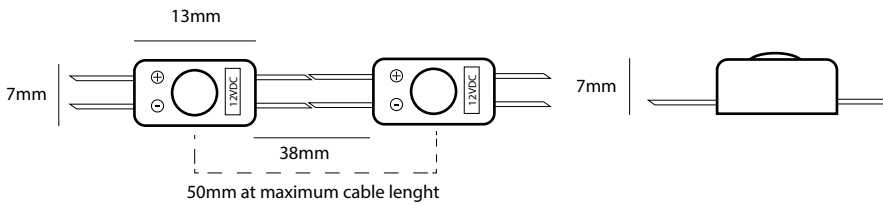

POWER SUPPLY CAPACITY 12V SERIES

Item	PP1230	PP1260	PP12100	PP12150	PP12200
Power Output	30W	60W	100W	150W	200W
BL10 modules / power supply	112	225	375	562	750
Number of chains (maximum 50 modules per chain)	3	4	8	12	15

PACKAGING

Item	Qty (pcs/bag)	Qty (bag / carton)	Total Qty (pcs / carton)	Total weight (kgs)	Carton size (LxWxH) in mm
BL10	300	20	6000	7.2	264 x 376 x 272



LUCOLED BL30



- *5 years warranty*
First 2 years extended warranty
- *Lucolense wide beam technology*
- *High efficacy*
- *Constant Current Technology*
- *Narrow white binning*

Lucoled Plus BL30 modules offer a high quality and efficient backlit solution for lightboxes with a depth of 100-300 mm.

Using the latest Top-Tier LED technology and high quality patented optics Lucoled Plus BL30 offers industry leading efficacy and coverage. This not only reduces the amount of modules needed for an application, but also the overall power consumption.

In a typical application of 125 mm deep only 9 modules per square meter are used at maximum wire spacing, making installation very fast and less labour intensive. Using only 32,4 W per square meter also the number of power supplies needed is strongly reduced.

SPECIFICATIONS

- Dimensions 169x32x10mm
- Warranty 5 years (first 2 years extended)
- Beam angle: 170°
- Can be cut between every unit
- UL, CE and RoHS compliant
- Narrow white binning
- Constant Current Technology
- Operating temperature -25~+60C



LUMINOUS INTENSITY DISTRIBUTION

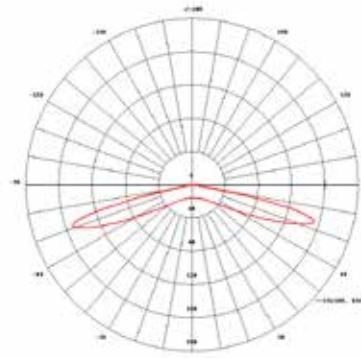

Item no	LED colour	CT (K)	CRI	Power (W/mod)	Flux (lm/mod)	Efficacy (lm/W)	Voltage (DC)	Modules per chain	Modules per carton
BL30-W65	white	6500	>70	3.6	350	97	12	15	300

DIMENSIONS

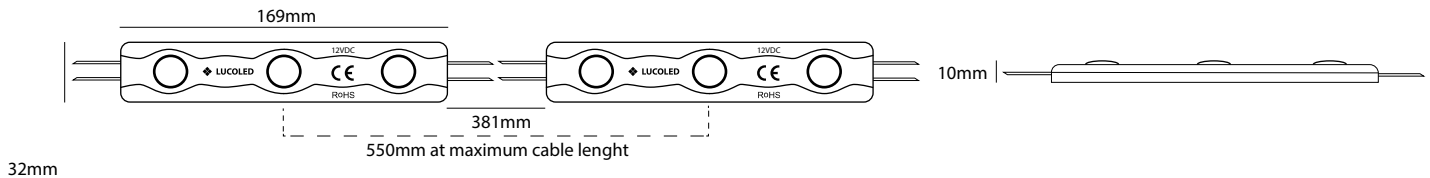

Light box depth (mm)	Space between modules (mm)	Installing density (pcs/m ²)	Surface luminance range (cd/m ²)
dz=100	dx=300, dy=250	13	900-1100
dz=150	dx=300, dy=500	7	400-450
dz=200	dx=300, dy=700	5	250-300
dz=250	dx=350, dy=900	3	160-180
dz=300	dx=350, dy=1100	3	160-180

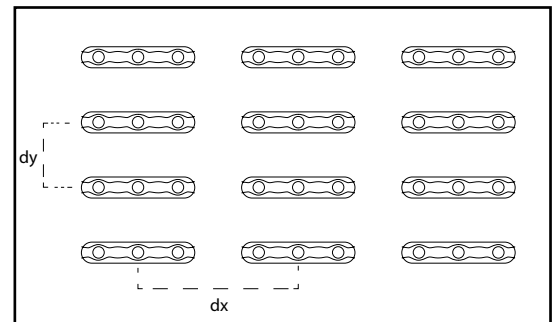

Results may vary depending on face material properties. The data above was obtained using 3mm thick opaque acrylic with a 54% light transmittance. Lucoled advises to paint the inside of the box/letters in a matt white colour for achieving an optimal result. Always test before production.

POWER SUPPLY CAPACITY 12V SERIES

Item	PP1230	PP1260	PP12100	PP12150	PP12200
Power Output	30W	60W	100W	150W	200W
BL30 modules / power supply	7	14	24	36	48
Number of chains (maximum 15 modules per chain)	1	1	2	3	4

PACKAGING

Item	Qty (pcs/bag)	Qty (bag / carton)	Total Qty (pcs / carton)	Total weight (kgs)	Carton size (LxWxH) in mm
BL30	30	10	300	19	528 x 376 x 272



LUCOLED BL70



- *5 years warranty*
First 2 years extended warranty
- *Lucolense wide beam technology*
- *High efficacy*
- *Constant Current Technology*
- *Narrow white binning*

Lucoled Plus BL70 modules offer a high quality and efficient backlit solution for lightboxes with a depth of 120-300 mm.

Using the latest Top-Tier LED technology and high quality patented optics Lucoled Plus BL70 offers industry leading efficacy and coverage. This not only reduces the amount of modules needed for an application, but also the overall power consumption.

In a typical application of 150 mm deep only 4 modules per square meter are used at maximum wire spacing, making installation very fast and less labour intensive. Using only 28 W per square meter also the number of power supplies needed is strongly reduced.

SPECIFICATIONS

- Dimensions 113x83x10mm
- Warranty 5 years (first 2 years extended)
- Beam angle: 160°
- Can be cut between every unit
- UL, CE and RoHS compliant
- Narrow white binning
- Constant Current Technology
- Operating temperature -25~+60C



LUMINOUS INTENSITY DISTRIBUTION

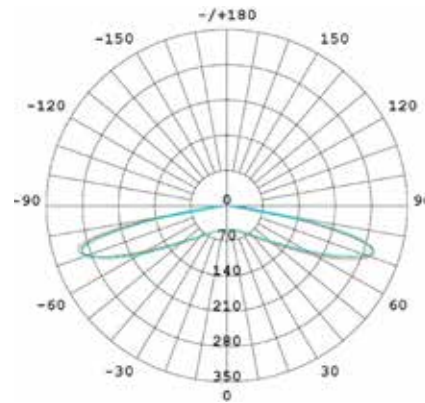

Item no	LED colour	CT (K)	CRI	Power (W/mod)	Flux (lm/mod)	Efficacy (lm/W)	Voltage (DC)	Modules per chain	Modules per carton
BL70-W65	white	6500	>70	7.0	850	121	24	10	80

DIMENSIONS

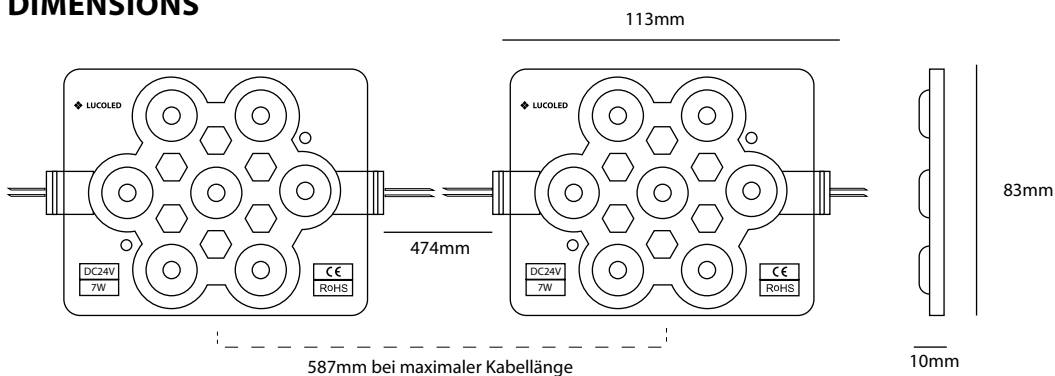

Light box depth (mm)	Space between modules (mm)	Installing density (pcs/m ²)	Surface luminance range (cd/m ²)
dz=120	dx=300, dy=300	9	1250-1350
dz=150	dx=450, dy=400	6	850-950
dz=180	dx=500, dy=500	4	450-550
dz=180	dx=450, dy=400	6	700-800
dz=180	dx=300, dy=300	9	1050-1150
dz=250	dx=500, dy=500	4	350-450

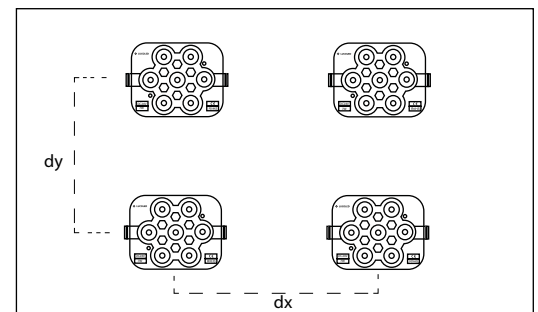

Results may vary depending on face material properties. The data above was obtained using 3mm thick opaque acrylic with a 54% light transmittance. LUCOLED advises to paint the inside of the box/letters in a matt white colour for achieving an optimal result. Always test before production.

POWER SUPPLY CAPACITY 24V SERIES

Item	PP2430	PP2460	PP24100	PP24150	PP24200
Power Output	30W	60W	100W	150W	200W
BL70 modules / power supply	3	7	13	19	25
Number of chains (maximum 10 modules per chain)	1	1	2	2	3

PACKAGING

Item	Qty (pcs/layer)	Qty (layers / carton)	Total Qty (pcs / carton)	Total weight (kgs)	Carton size (LxWxH) in mm
BL70	20	4	80	13	528 x 376 x 272



LUCOLED EL10



- *5 years warranty*
First 2 years extended warranty
- *Lucolense narrow beam technology*
- *High efficacy*
- *Constant Current Technology*
- *Narrow white binning*

Lucoled Edge Lighting EL10 modules offer a high quality and efficient solution for single-sided signs with a depth of 70-200 mm and double-sided signs with a depth of 80-400 mm, max. 1000 mm wide.

Lucoled EL10 uses patented light reflection technology to evenly illuminate single and double-sided small light boxes and signs. The licensed technology is based on the face being illuminated by over 70% indirect, internally reflecting, light transmitted by narrow beam flare lenses. The modules are mounted on the sides of the box, directing a beam of light at the opposite side. The reflecting light evenly illuminates the face.

EL10 is ideal for round, oval or any other non-rectangular shaped sign as the individual modules can be positioned following the shape of the sides.

SPECIFICATIONS

- Dimensions 50x30x14mm
- Warranty 5 years (first 2 years extended)
- Beam angle: 19° * 32°
- Can be cut between every unit
- UL, CE and RoHS compliant
- Narrow white binning
- Constant Current Technology
- Operating temperature -25~+60C

LUMINOUS INTENSITY DISTRIBUTION

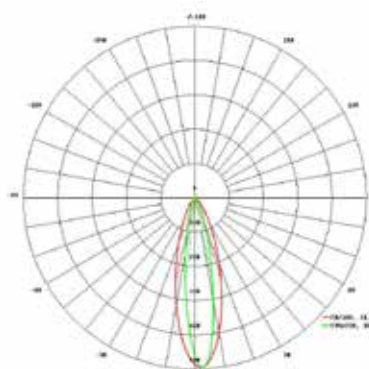

Item no	LED colour	CT (K)	CRI	Power (W/mod)	Flux (lm/mod)	Efficacy (lm/W)	Voltage (DC)	Modules per chain	Modules per carton
EL10-W65	white	6500	>70	1.6	160	100	12	25	600

DIMENSIONS

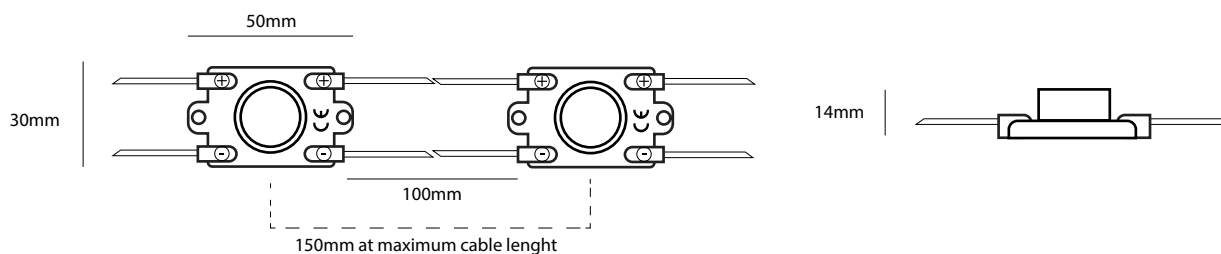

POWER SUPPLY CAPACITY 12V SERIES

Item	PP1230	PP1260	PP12100	PP12150	PP12200
Power Output	30W	60W	100W	150W	200W
EL10 modules / power supply	16	33	56	84	112
Number of chains (maximum 25 modules per chain)	1	2	3	4	5

PACKAGING

Item	Qty (pcs/bag)	Qty (bag / carton)	Total Qty (pcs / carton)	Total weight (kgs)	Carton size (LxWxH) in mm
EL10	50	12	600	10,5	528 x 376 x 272



LUCOLED EL30



- *5 years warranty*
- *First 2 years extended warranty*
- *Lucolense narrow beam technology*
- *High efficacy*
- *Constant Current Technology*
- *Narrow white binning*

Lucoled Edge Lighting EL30 modules offer a high quality and efficient solution for single-sided lightboxes with a depth of 50-100 mm and double-sided lightboxes with a depth of 100-150 mm, max. 1000 mm wide.

Lucoled EL30 uses patented light reflection technology to evenly illuminate single and double-sided medium size light boxes and signs. The licensed technology is based on the face being illuminated by over 70% indirect, internally reflecting, light transmitted by narrow beam flare lenses. The modules are mounted on the sides of the box, directing a beam of light at the opposite side. The reflecting light evenly illuminates the face.

EL30 is ideal for medium size rectangular shaped signs. The individual modules are normally positioned on opposite sides on the longest side of the sign.

SPECIFICATIONS

- Dimensions 120x23x11mm
- Warranty 5 years (first 2 years extended)
- Beam angle: 18° * 25°
- Can be cut between every unit
- UL, CE and RoHS compliant
- Narrow white binning
- Constant Current Technology
- Operating temperature -25~+60C

LUMINOUS INTENSITY DISTRIBUTION

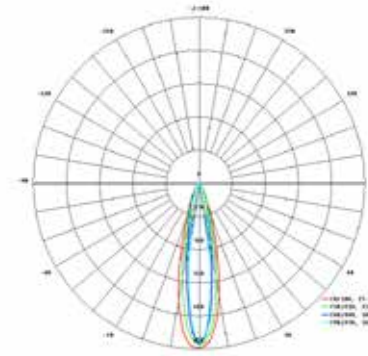

Item no	LED colour	CT (K)	CRI	Power (W/mod)	Flux (lm/mod)	Efficacy (lm/W)	Voltage (DC)	Modules per chain	Models per carton
EL30-W65	white	6500	>70	2.88	327	114	12	20	480

DIMENSIONS

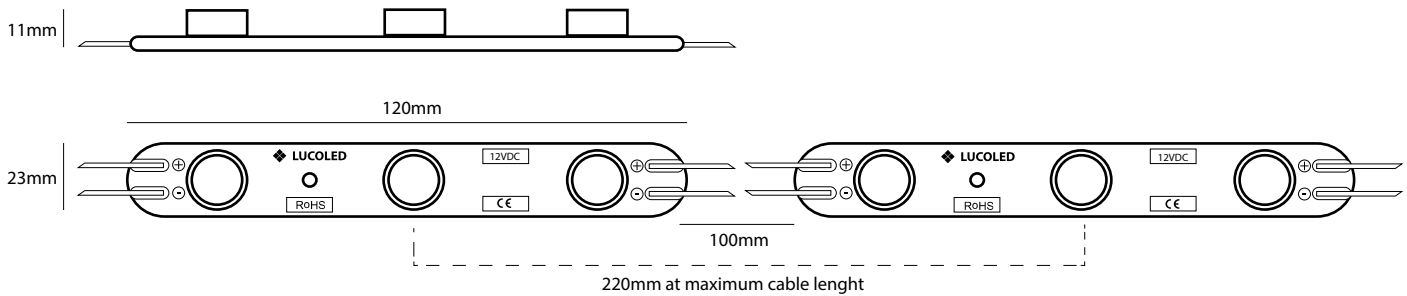

POWER SUPPLY CAPACITY 12V SERIES

Item	PP1230	PP1260	PP12100	PP12150	PP12200
Power Output	30W	60W	100W	150W	200W
EL30 modules / power supply	9	18	31	46	62
Number of chains (maximum 20 modules per chain)	1	1	2	3	4

PACKAGING

Item	Qty (pcs/bag)	Qty (bag / carton)	Total Qty (pcs / carton)	Total weight (kgs)	Carton size (LxWxH) in mm
EL30	60	8	480	14,5	528 x 376 x 272



LUCOLED EL35



- *5 years warranty*
- *Lucolense narrow beam technology*
- *High efficacy*
- *Constant Current Technology*
- *Narrow white binning*
- *For illuminating 3m wide lightboxes*

Lucoled Edge Lighting EL35 modules offer a high quality and efficient solution for single-sided lightboxes with a depth of 100-120 mm and double-sided lightboxes with a depth of 125-180 mm, max. 3000 mm wide.

Lucoled EL35 uses patented light reflection technology to evenly illuminate single and double-sided large format light boxes. The licensed technology is based on the face being illuminated by over 70% indirect, internally reflecting, light transmitted by narrow beam flare lenses. The modules are mounted on the sides of the box, directing a beam of light at the opposite side.

EL35 is ideal for large size rectangular shaped signs. The individual modules are normally positioned on opposite sides on the longest side of the sign.

SPECIFICATIONS

- Dimensions 142x30x15mm
- Warranty 5 years
- Beam angle: 10° * 40°
- Can be cut between every unit
- UL, CE and RoHS compliant
- Narrow white binning
- Constant Current Technology
- Operating temperature -25~+60C

LUMINOUS INTENSITY DISTRIBUTION

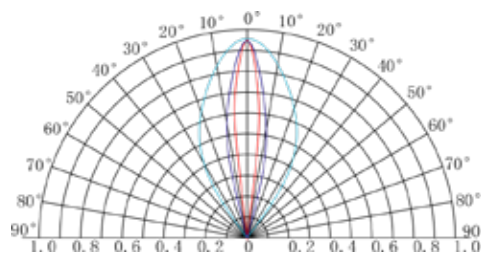

Item no	LED colour	CT (K)	CRI	Power (W/mod)	Flux (lm/mod)	Efficacy (lm/W)	Voltage (DC)	Modules per chain	Modules per carton
EL35-W70	white	7000	>75	6.0	780	130	24	15	75

DIMENSIONS

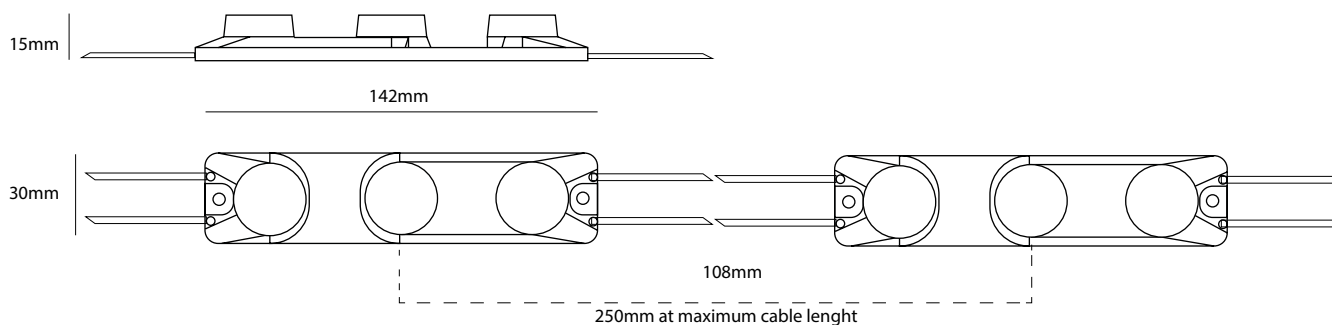

POWER SUPPLY CAPACITY 24V SERIES

Item	PP2430	PP2460	PP24100	PP24150	PP24200
Power Output	30W	60W	100W	150W	200W
EL35 modules / power supply	4	9	15	22	30
Number of chains (maximum 15 modules per chain)	1	1	1	2	2

PACKAGING

Item	Qty (pcs/ layer)	Qty (layer / carton)	Total Qty (pcs / carton)	Total weight (kgs)	Carton size (LxWxH) in mm
EL35	15	5	75	7,88	415x255x180



LUCOLED ELP60



- *5 years warranty*
- *AC110-220V driver included*
- *Lucolense narrow beam technology*
- *Constant Current Technology*
- *High-output LEDs with narrow white binning*
- *Aluminium shell UL94V-0*

Lucoled Edge Lighting ELP60 modules offer a high quality and efficient solution for double-sided lightboxes with a depth of 120-400 mm, max. 2000mm wide. The module includes a high-voltage wide input constant current driver.

Lucoled ELP60 uses patented light reflection technology to evenly illuminate single and double-sided large format light boxes. The licensed technology is based on the face being illuminated by over 70% indirect, internally reflecting, light transmitted by narrow beam flare lenses. The modules are mounted on the sides of the box, directing a beam of light at the opposite side.

The ELP60 can be connected directly to the mains power supply as it has an integrated driver. Especially in edge lighting applications an external driver mounted inside the box can create dark spots as it disrupts the internal reflection technology.

The ELP60 modules can be linked without gap using a connector or with a small cable.

SPECIFICATIONS

- Dimensions 495x32,4x23,3mm
- Warranty 5 years
- Beam angle: 10° * 45°
- UL, CE and RoHS compliant
- Narrow white binning
- Constant Current Technology
- Operating temperature -25~+60C

LUMINOUS INTENSITY DISTRIBUTION

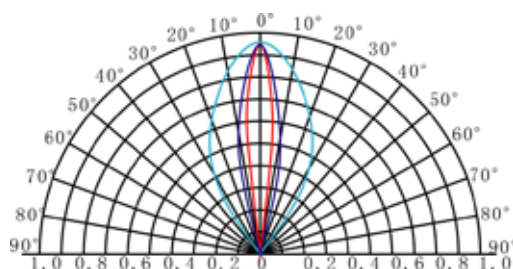

Item no	LED colour	CT (K)	CRI	Power (W/mod)	Flux (lm/mod)	Efficacy (lm/W)	Voltage (AC)	Modules per chain	Models per carton
ELP60-W70	white	7000	>70	18.0	1350	75	110-220	20	42

DIMENSIONS

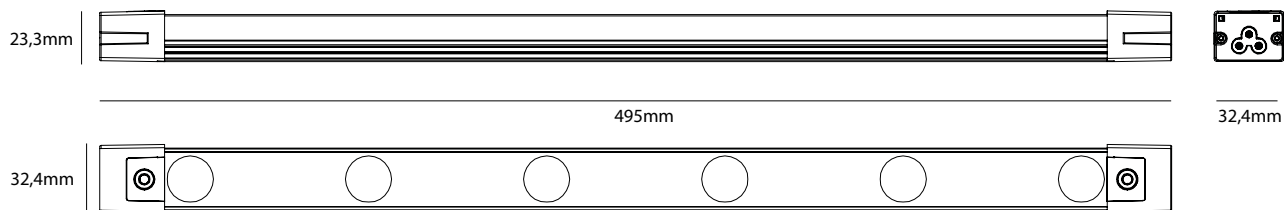

PACKAGING

Item	Qty (pcs/box)	Qty (box / carton)	Total Qty (pcs / carton)	Total weight (kgs)	Carton size (LxWxH) in mm
ELP60	1	42	42	13,5	583x242x270



LUCOLED ELI



- *5 years warranty*
- *Lucolense narrow beam technology*
- *High efficacy*
- *Quick Connector in WAGO or AMPR plug*
- *Constant Current Technology*
- *Narrow white binning*
- *Customized length available*

Lucoled Edge Lighting ELI modules offer a high quality and efficient solution for Indoor single-sided lightboxes with a depth of 60-100 mm and double-sided lightboxes with a depth of 100-200 mm, max. 2000 mm wide.

Lucoled ELI uses patented light reflection technology to evenly illuminate single and double-sided medium and large format indoor light boxes. The licensed technology is based on the face being illuminated by over 70% indirect, internally reflecting, light transmitted by narrow beam flare lenses. The modules are mounted on the sides of the box, directing a beam of light at the opposite side.

Lucoled ELI modules are ideal for medium and large size rectangular shaped indoor signs. The individual modules are normally positioned on opposite sides on the longest side of the sign. The modules can be linked in a chain easily as they come with connectors on both sides.

SPECIFICATIONS

- Dimensions:
 ELI30: 219x25x14,8mm
 ELI50: 365x25x14,8mm
 ELI60: 438x25x14,8mm
- Warranty 5 years
- Beam angle: 7° * 30°
- UL, CE and RoHS compliant
- Narrow white binning
- Constant Current Technology
- Operating temperature -25~+60C

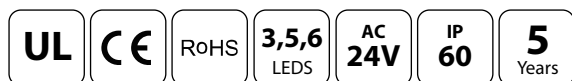

LUMINOUS INTENSITY DISTRIBUTION

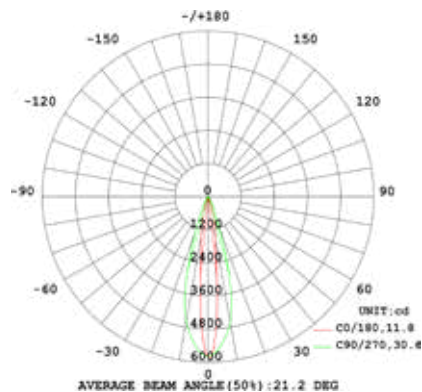

Item no	LED colour	CT (K)	CRI	Power (W/mod)	Flux (lm/mod)	Efficacy (lm/W)	Voltage (DC)	Modules per chain	Models per carton
ELI30-W65	white	6500	>70	7,92	807	102	24	10	160
ELI50-W65	white	6500	>70	13.20	1346	102	24	6	160
ELI60-W65	white	6500	>70	15,50	1581	102	24	5	140

DIMENSIONS

ELI30

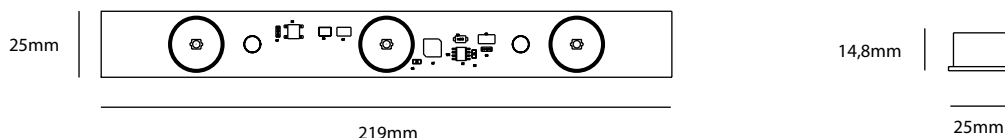

ELI50

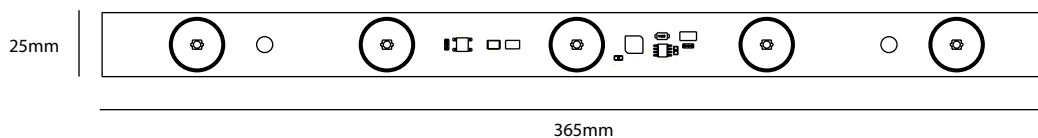

ELI60

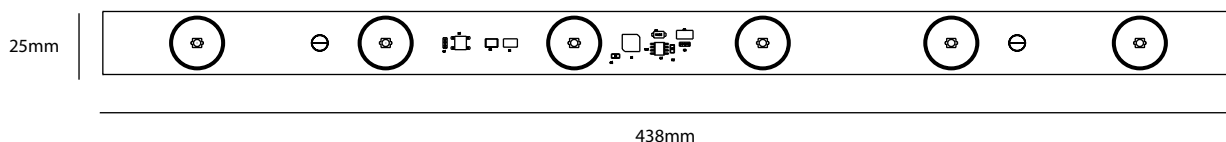

POWER SUPPLY CAPACITY 24V SERIES

Item	PP2430	PP2460	PP24100	PP24150	PP24200
Power Output	30W	60W	100W	150W	200W
ELI30 modules / power supply	3	6	11	17	22
Number of ELI30 chains (max. 10 modules per chain)	1	1	2	2	3
ELI50 modules / power supply	2	4	6	10	13
Number of ELI50 chains (max. 6 modules per chain)	1	1	1	2	3
ELI60 modules / power supply	1	3	5	8	11
Number of ELI60 chains (max. 5 modules per chain)	1	1	1	2	3

PACKAGING

Item	Qty (pcs/bag)	Qty (bag / carton)	Total Qty (pcs / carton)	Total weight (kgs)	Carton size (LxWxH) in mm
ELI30	1	160	160	10,28	550x400x340
ELI50	1	160	160	12,35	550x400x340
ELI60	1	140	140	12,78	550x400x340



LUCOLINE30



- *The most reliable border tubing in the industry*
- *Long (> 80.000hrs) and maintenance-free life*
- *5 year extended warranty*
- *Adjustable lengths available, cuttable every 55mm*
- *Bright and consistent illumination*
- *Current sense circuit - patented safety device*
- *Safe to touch with zero shock risk*
- *Runs up to 90 meters on only one power supply*
- *Fast and easy installation*

LucoLINE has been used around the world to illuminate the properties of countless blue-chip customers. It's perfect for use in public access areas such as retail stores, clubs and pubs, restaurants, cinemas, service stations, supermarkets and casinos.

In fact, anywhere that a flexible, 100% safe product with a pure and even spread of light is needed.

Available in a wide range of colours, LucoLINE30 is an illuminated, extruded, 30mm diameter, acrylic tube that uses Light Emitting Diodes (LEDs) as its light source.

It's specifically designed for highlighting buildings, signage, displays and POS as a more reliable, robust, low power and long lasting alternative to neon/cold cathode glass tubes.

SPECIFICATIONS

- Dimensions:
30mm (W) x 45mm (H)
Lengths: 2.4m fixed, 2.4m adjustable, 1.2m adjustable
Cutttable every 55mm
- 5 year extended warranty
- Housing material in extruded PMMA composite
- Mounting clips in UV stabilized polycarbonate
- Mounting clip pull force >17kgs
- Mounting clip shear force >30kgs
- JST JWPF IP67 connectors
- Constant Current Technology
- Protection class IP66
- Operating temperature -30°C ~ +60°C

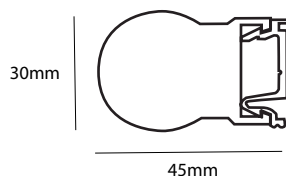
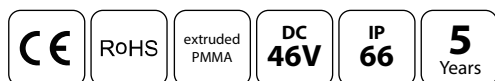

LUCOLINE30 TUBES

Item no	Description	Brightness	Daytime colour	NW/m
L-17005	Red - 2.4m fixed			
L-17006	Red - 2.4m adjustable	450cd/m2	PMS 1797	5.0W/m
L-17007	Red - 1.2m adjustable			
L-17002	Orange - 2.4m fixed			
L-17003	Orange - 2.4m adjustable	1200cd/m2	PMS 172	5.0W/m
L-17004	Orange - 1.2m adjustable			
L-17011	Yellow - 2.4m fixed			
L-17012	Yellow - 2.4m adjustable	1900cd/m2	PMS 116	5.0W/m
L-17013	Yellow - 1.2m adjustable			
L-17198	Amber - 2.4m fixed			
L-17197	Amber - 2.4m adjustable	1600cd/m2	PMS 7406	5.0W/m
L-17196	Amber - 1.2m adjustable			
L-17125	Light Green - 2.4m fixed			
L-17126	Light Green - 2.4m adjustable	300cd/m2	RAL 120 70 75	1.8W/m
L-17127	Light Green - 1.2m adjustable			
L-16996	Blue - 2.4m fixed			
L-16997	Blue - 2.4m adjustable	100cd/m2	PMS 280	5.0W/m
L-16998	Blue - 1.2m adjustable			
L-17008	White - 2.4m fixed			
L-17009	White - 2.4m adjustable	2250cd/m2	N/A	5.0W/m
L-17010	White - 1.2m adjustable			

ACCESSORIES

Item no	Description
L-17014	connection cable 1m
L-17015	connection cable 3m
L-17016	connection cable 5m
L-17017	connection cable 10m
L-17021	Y connector
L-17213	high friction mounting clip
L-17215	mounting clip (bag of 3)
L-17022	mounting clip
L-17023	blanking terminal
L-17205	amber end cap (bag of 10)
L-17199	blue end cap (bag of 10)
L-17200	light green end cap (bag of 10)
L-17201	orange end cap (bag of 10)
L-17202	red end cap (bag of 10)
L-17203	white end cap (bag of 10)
L-17204	yellow end cap (bag of 10)
L-17283	purple end cap (bag of 10)
L-17053	field endcap glue

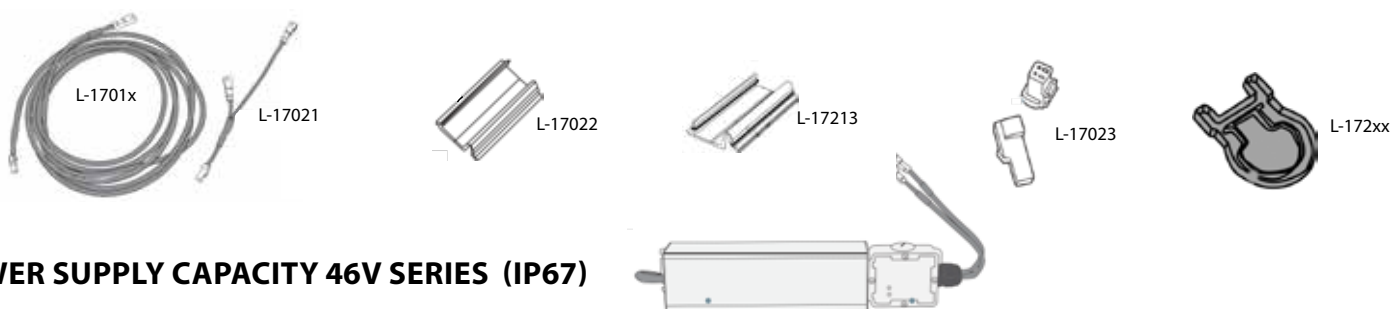

POWER SUPPLY CAPACITY 46V SERIES (IP67)

Power Supplies	L17018	L17019	L17020	L17081
LucoLINE30 colours	46VDC - 240W	46VDC - 96W	46VDC - 40W	46VDC - 25W
Light Green (1.8W/m)	2 x 45m	45m	20m	11m
Other colours (5.0W/m)	2 x 22m	18m	7m	4m



LUCOFLEX



- *Extremely flexible, UV stable, impact resistant and flame retardant silicon extrusion*
- *Protection class IP68*
- *5 year warranty*
- *Wide colour pallet, daytime colours when non-illuminated*
- *Bright, dot-free and homogeneous light*
- *Runs up to 15 meters on only one power supply*
- *Adjustable in length, cuttable every 50mm*
- *Interfaces with all automation and control systems*

LucoFLEX is the world's first worthy alternative to neon lighting and signage. With its extreme flexibility and wide colour pallet LucoFLEX provides neon artists and lighting designers the creative freedom they are looking for, while still delivering a high-efficient, reliable, long life and maintenance free solution.

LucoFLEX is perfect for architectural exterior and interior lighting applications as it provides high performance, dot-free and homogeneous light, ideal for highlighting the perimeters and outlines of buildings, canopies, letters, signs and open-face channel letters.

Our flexible, IP68 protected silicon extrusion is UV stable, impact resistant, flame retardant and has a high resistance to chemicals and environmental influences, and is therefore backed by our 5 year warranty.

SPECIFICATIONS

- Dimensions:
10mm (W) x 25mm (H)
Lengths of 15m (cuttable every 50mm)
Cuttable every 50mm
- UV stable, impact resistant and flame retardant silicon extrusion
- 5 year warranty
- In-field flat bend of 25mm
- UL, CE and RoHS compliant
- Constant Current Technology
- Power per meter: 9.6W/m
- Protection class IP68
- Operating temperature -25°C ~ +60°C
- in-field flat bend of 25mm (radius)

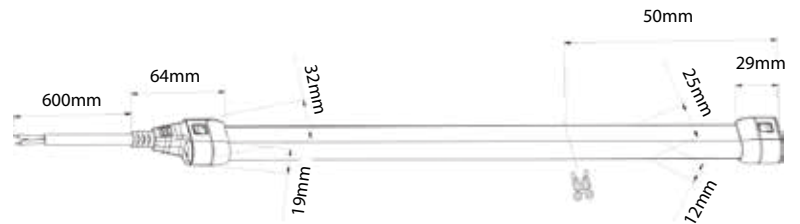
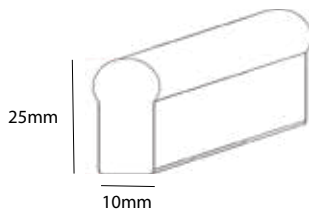
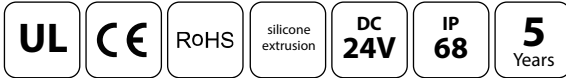

LUCOFLEX TUBES

Item no	Description	Daytime colour	Nom. W/m
F-03000-W	Warm white - 15m adjustable	3000K	9.6W/m
F-04200-W	Daylight white - 15m adjustable	4200K	9.6W/m
F-06500-W	Cool white - 15m adjustable	6500K	9.6W/m
F-00585-Y	Yellow - 15m adjustable	585-590nm	9.6W/m
F-00620-R	Red - 15m adjustable	620-625nm	9.6W/m
F-00520-G	Green - 15m adjustable	520-525nm	9.6W/m
F-00465-B	Blue - 15m adjustable	465-470nm	9.6W/m
F-00600-O	Orange - 15m adjustable	600-605nm	9.6W/m
F-30000-F	Fuchsia - 15m adjustable	25000-35000K	9.6W/m
F-00400-P	Purple - 15m adjustable	400-410nm	9.6W/m

ACCESSORIES

Item no	Description
F-18001	Aluminium Mounting Channel
F-18002	Aluminium Mounting Clip



POWER SUPPLY CAPACITY 24V SERIES

Power Supplies	PP24200	PP24150	PP24100	PP2460	PP2430
	24VDC - 200W	24VDC - 150W	24VDC - 100W	24VDC - 60W	24VDC - 30W
All LucoFLEX colours (9.6W/m)	15m	14m	9m	5.6m	2.8m



LUCOFLEX SLIM

- *Extremely flexible, UV stable, impact resistant and flame retardant silicon extrusion*
- *Protection class IP67*
- *5 year warranty*
- *Wide colour pallet, daytime colours when non-illuminated*
- *Bright, dot-free and homogeneous light*
- *Adjustable in length, cuttable every 55mm*
- *Interfaces with all automation and control systems*

LucoFLEX SLIM is the most flexible neon-replacement product currently available. It can be bent in a very small radius, allowing full artistic freedom as with traditional neon.

The product is made with the latest in-mold silicon extrusion technology, UV resistant, weatherproof, non-yellowing.

LucoFLEX slim is a true low-power LED replacement for small neon signs and art pieces, available in 6 bright, even, colours.

SPECIFICATIONS

- Dimensions:
5mm (W) x 11mm (H)
Lengths of 5m (cuttable every 55mm)
Cuttable every 55mm
- UV stable, impact resistant and flame retardant silicon extrusion
- 5 year warranty
- UL, CE and RoHS compliant
- Constant Current Technology
- Power per meter: 10,8W/m
- Protection class IP67
- 600-650lm/m
- Operating temperature -25°C ~ +60°C
- in-field flat bend of 10mm (radius)

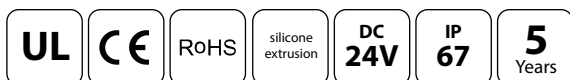
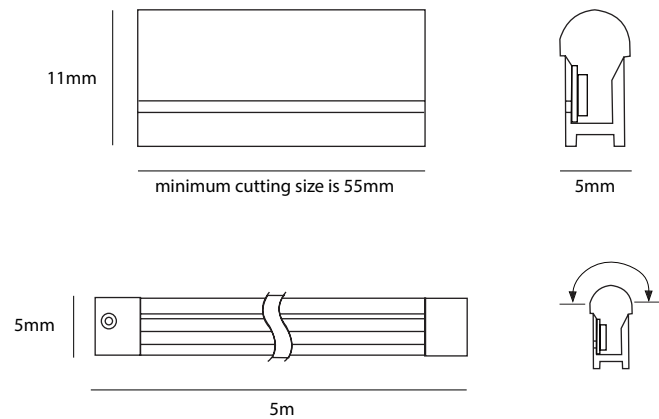

LUCOFLEX TUBES

Item no	Description		Daytime colour	Nom. W/m
FS-3000-W	Warm white - 5m adjustable		3000K	10,8W/m
FS-6000-W	Cool white - 5m adjustable		6000K	10,8W/m
FS-00585-Y	Yellow - 5m adjustable		585-590nm	10,8W/m
FS-00620-R	Red - 5m adjustable		620-625nm	10,8W/m
FS-00520-G	Green - 5m adjustable		520-525nm	10,8W/m
FS-00465-B	Blue - 5m adjustable		465-470nm	10,8W/m

ACCESSORIES

Item no	Description
FS-18001	Silicon wire 200mm
FS-18002	Silicon endcap
FS-18003	RVS mounting clip
FS-18004	Silica Gel

POWER SUPPLY CAPACITY 24V SERIES

Power Supplies	PP24200	PP24150	PP24100	PP2460	PP2430
	24VDC - 200W	24VDC - 150W	24VDC - 100W	24VDC - 60W	24VDC - 30W
All LucoFLEX Slim tubes (10,8W/m)	17m	12,5m	8m	5m	2,5m



LUCOLED POWER SOURCES

- *7 years warranty / 70.000 hours
First 2 years extended warranty*
- *Wide Voltage Input*
- *OVP, OCP, SCP, OTP protection function*
- *IP68 Rating*

Lucoled offers a full range of Premium Power Sources. The various power options help you to match the installed power capacity to the total power used by your LED installation.

Lucoled Premium Power Sources are designed and tested for safety, long life and reliability.

All power supplies are designed for outdoor use and carry all required international agency markings.

SPECIFICATIONS 12V POWER SUPPLIES

Output Voltage	12V
Working temperature range	-40°C~+65°C
Input Voltage Range	100VAC~240VAC
Input Frequency Range	50~60Hz
Protective Characteristics	Over-Current, Short-Circuit, Over Voltage and Over-Temperature protection
IP Rating	IP68
MTBF	≥70000hrs. MIL-HDBK-217F(25°C)

Code	Output Current	Output Power	Input Current	Efficiency	Size (l x w x h)	Weight
PP1230	2.5A	30W	0.35A/115V - 0.19A/230V	≥83%	187x41x29mm	0,5kg
PP1260	5A	60W	0.65A/115V - 0.35A/230V	≥86%	184x44x34mm	0,52kg
PP12100	8.33A	100W	1.1A/115V - 0.55A/230V	≥90%	204x67x35mm	0,88kg
PP12150	12.5A	150W	1.6A/115V - 0.8A/230V	≥92%	234x68x35mm	1kg
PP12200	16A	200W	2.8A max	≥88%	295x60x36mm	1,1kg

SPECIFICATIONS 24V POWER SUPPLIES

Output Voltage	24V
Working temperature range	-40°C~+65°C
Input Voltage Range	100VAC~240VAC
Input Frequency Range	50~60Hz
Protective Characteristics	Over-Current, Short-Circuit, Over Voltage and Over-Temperature protection
IP Rating	IP68
MTBF	≥70000hrs. MIL-HDBK-217F(25°C)

Code	Output Current	Output Power	Input Current	Efficiency	Size (l x w x h)	Weight
PP2430	1.25A	30W	0.35A/115V - 0.19A/230V	≥84%	187x41x29mm	0,5kg
PP2460	2.5A	60W	0.65A/115V - 0.35A/230V	≥87%	157x44x34mm	0,52kg
PP24100	4.16A	100W	1.1A/115V - 0.55A/230V	≥92%	204x67x35mm	0,88kg
PP24150	6.25A	150W	1.6A/115V - 0.8A/230V	≥93%	234x68x35mm	1kg
PP24200	8.34A	200W	2.8A max	≥90%	295x60x36mm	1,1kg



IP68

Important:

- Lucoled recommends loading power supplies up to 90% of their maximum listed capacity.
- Select a power supply for your installation loaded at more than 50% of its maximum load to meet Power Factor regulations.
- Install with adequate ventilation and not in direct sunlight.
- Power supplies to be installed by trained and certified staff.



LUCOLED

Experience Lighting

LUCOLED NV

Industriepark 32b
3290 Diest
Belgium

www.lucoled.com

P: +32 (0)13 292829
E: info@lucoled.com

LUCOLED NV

Rotterdamseweg 388F
2629 HG Delft
The Netherlands

YOUR DEALER: